

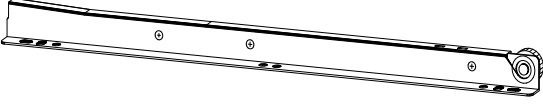

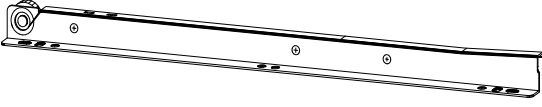

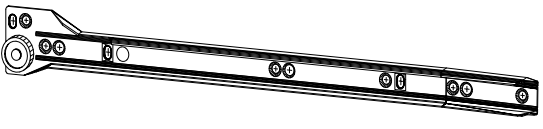

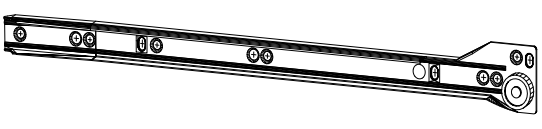

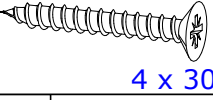
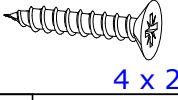
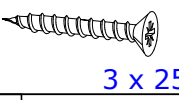
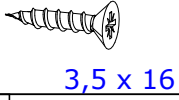
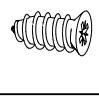

T	3 x		L 350	I	3 x		L 350
B	3 x		L 350	C	3 x		L 350
A	16 x		8 x 35	L	12 x		4 x 30
LO	12 x		4 x 25	K	20 x		3 x 25
X	16 x		3,5 x 16	M	8 x		
ML	28 x			M1	28 x		
D	12 x			P	1 x		
E	12 x			G	82 x		
K1	8 x						
ZN	4 x						
ZP	2 x						
NP	6 x		60 x 40 x 20				
UL	6 x						
MZ	28 x						

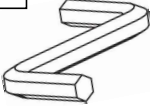
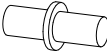

B L 350	C L 350		
A 8 x 35	ML 16 x	M 8 x	X 3,5 x 16

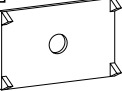
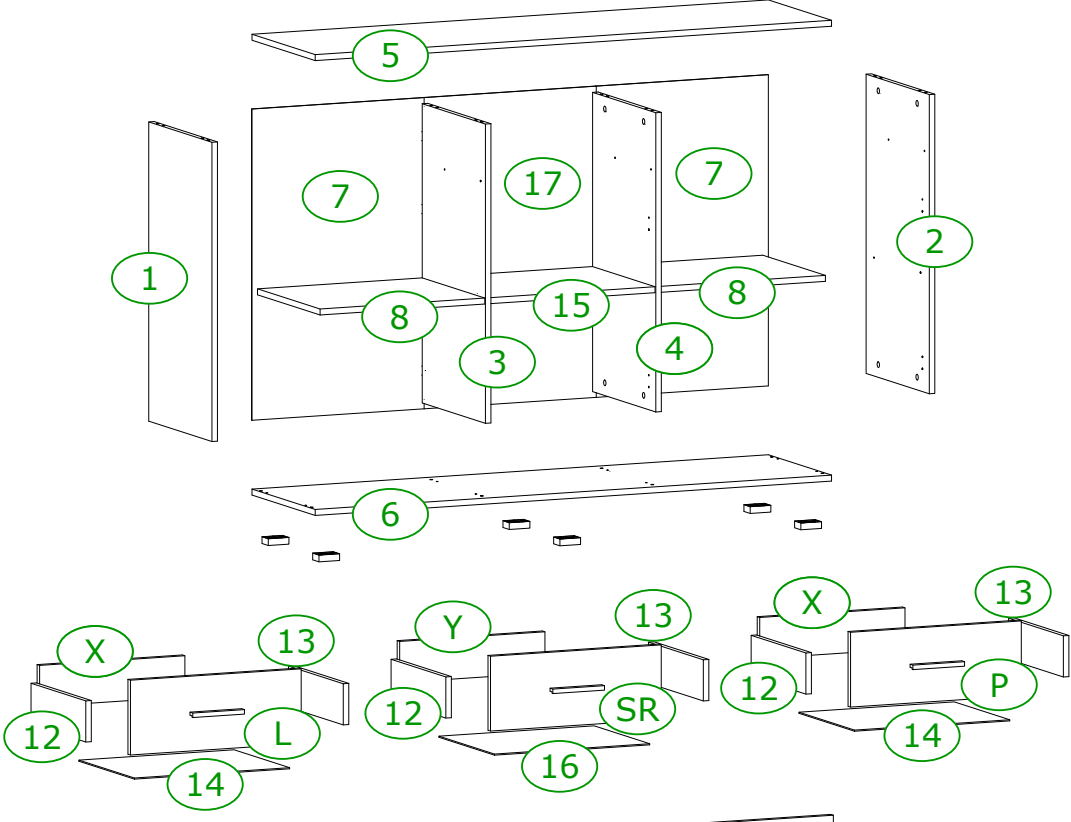
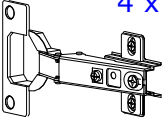
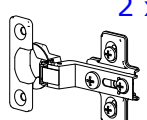
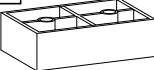

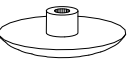
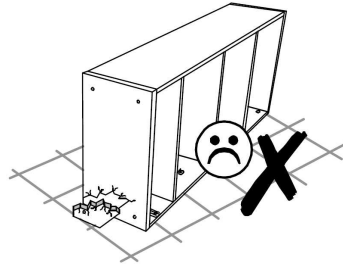
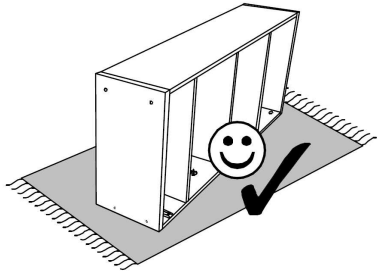
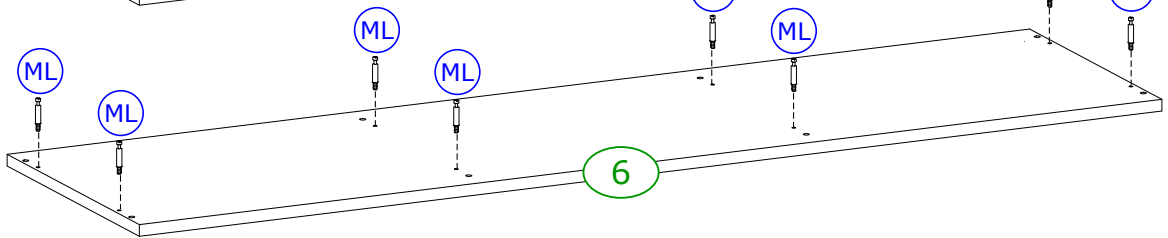
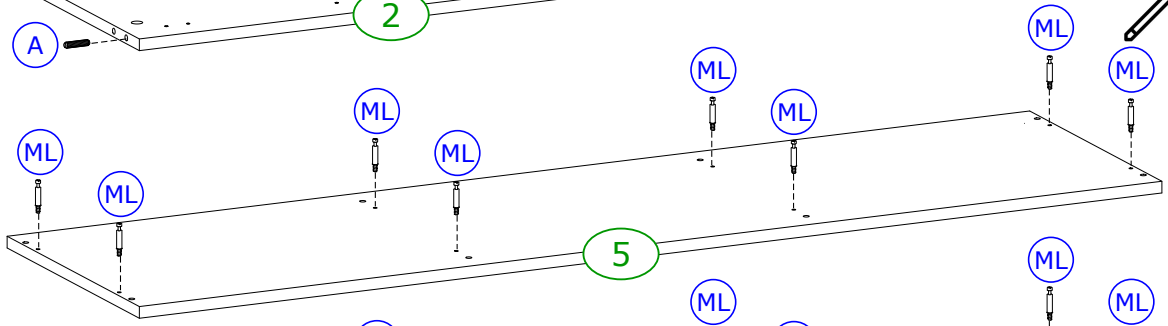
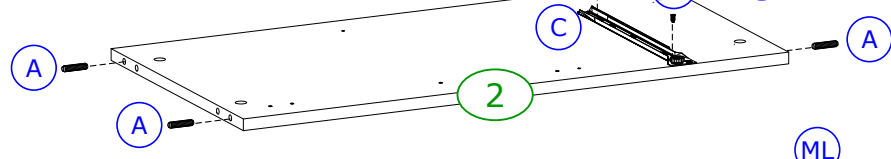
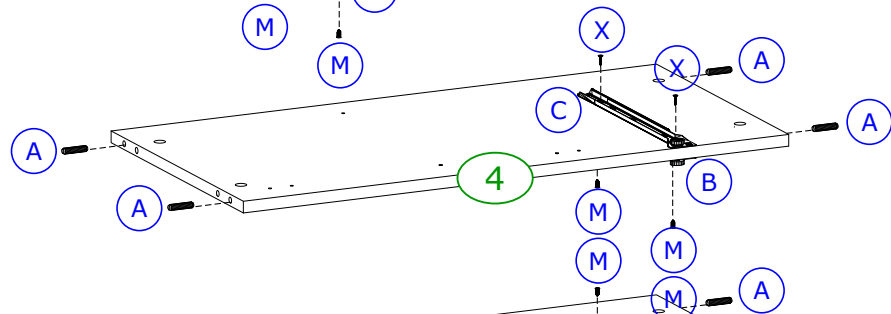
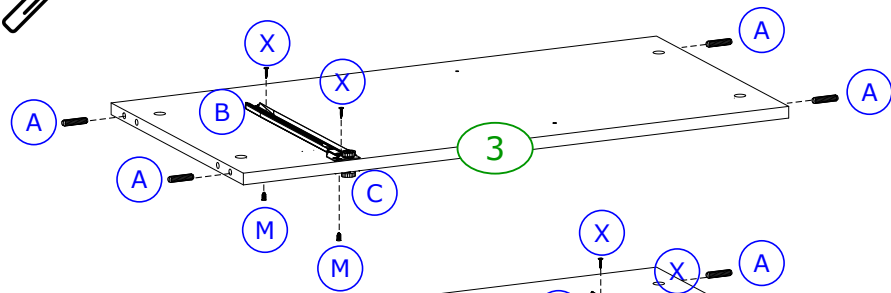
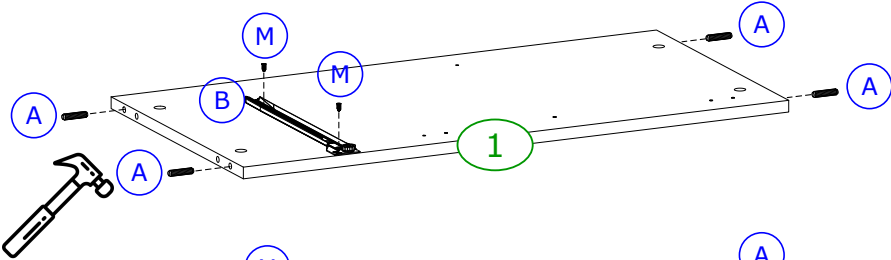
1

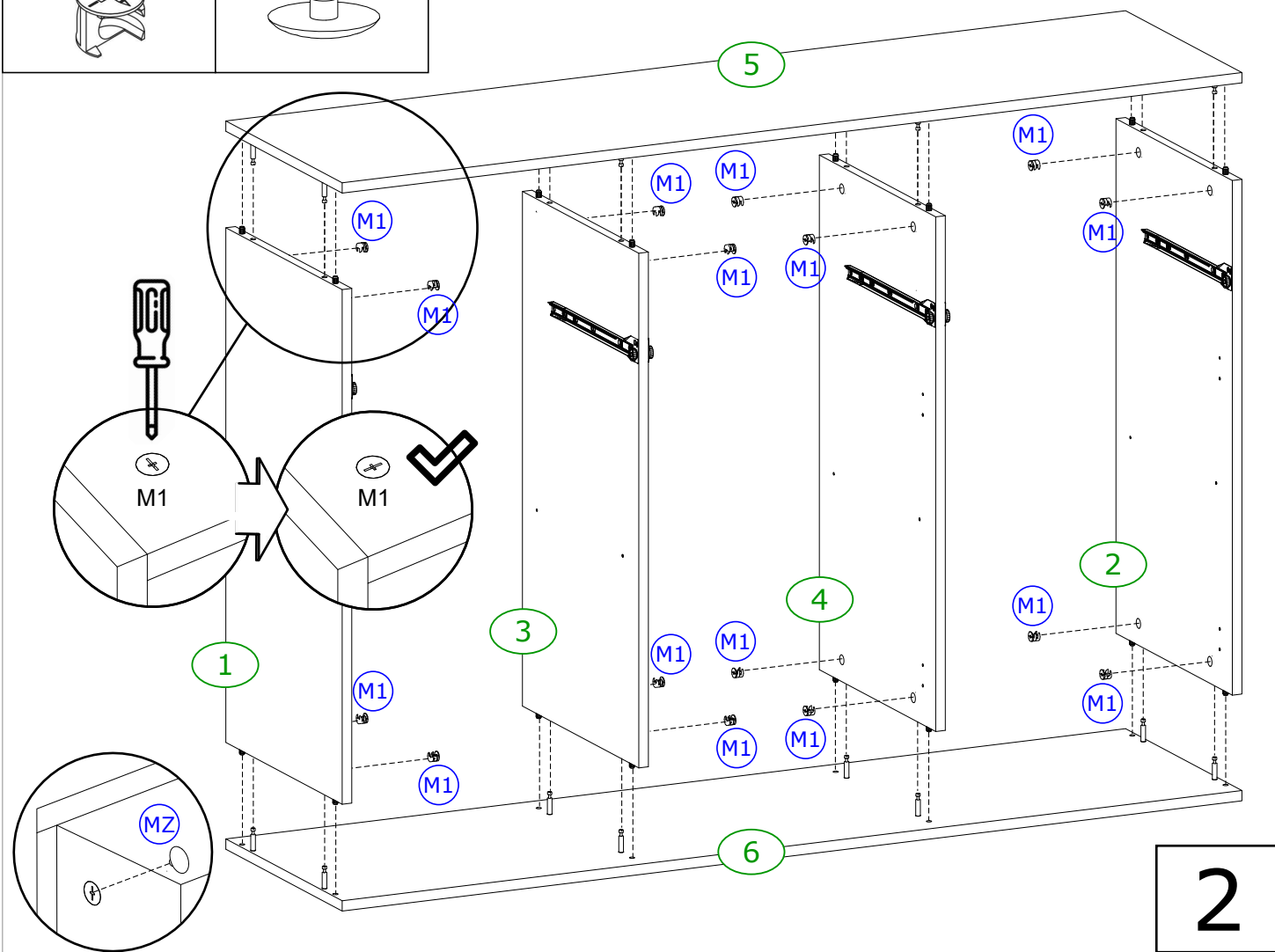
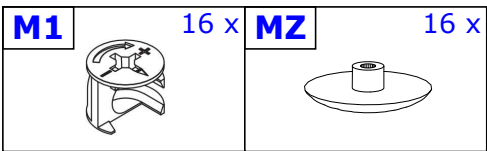

2

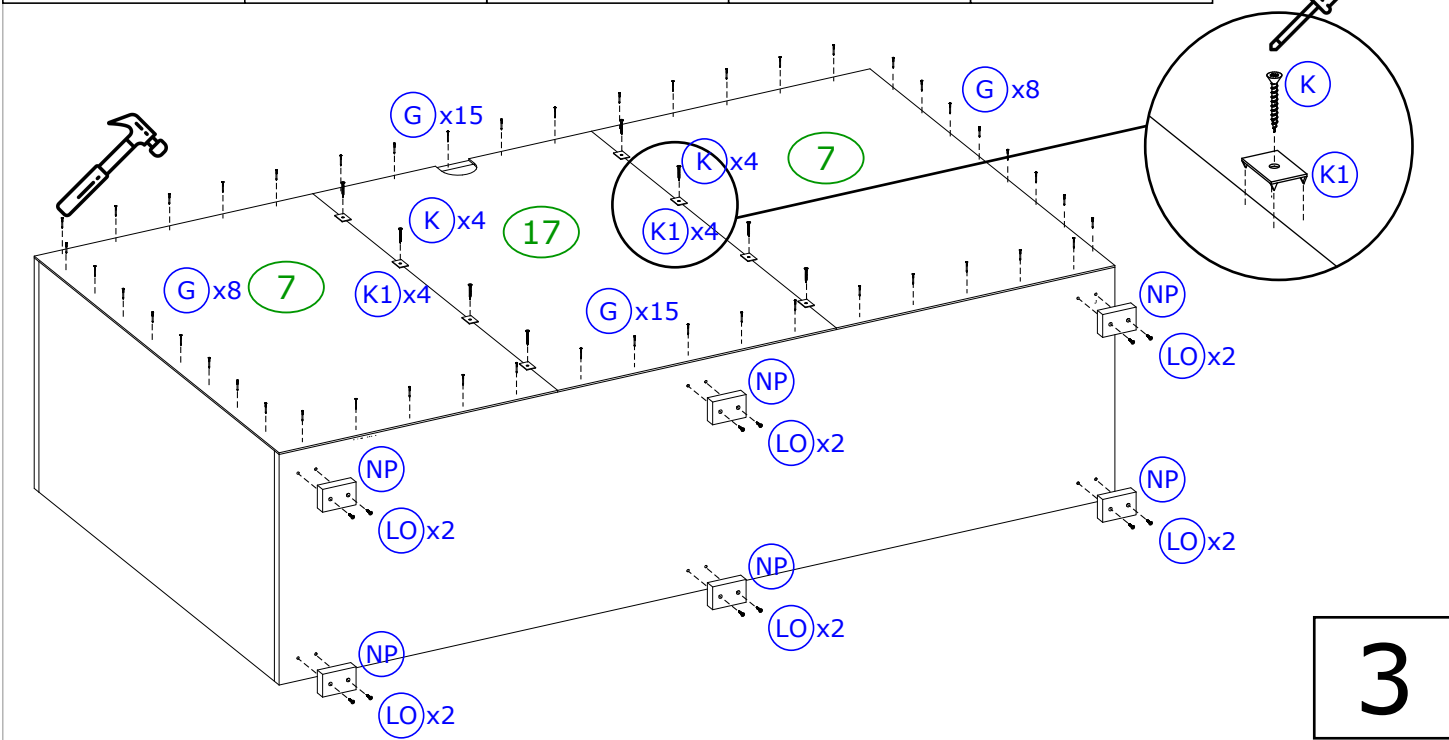
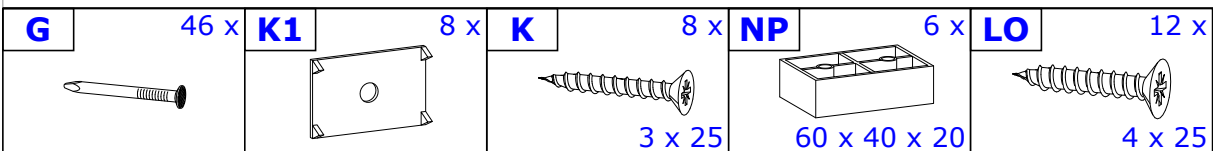

3

D	12 x	P	1 x	ML	12 x	M1	12 x	K	12 x	G	36 x
T	3 x			I	3 x						

MZ	12 x

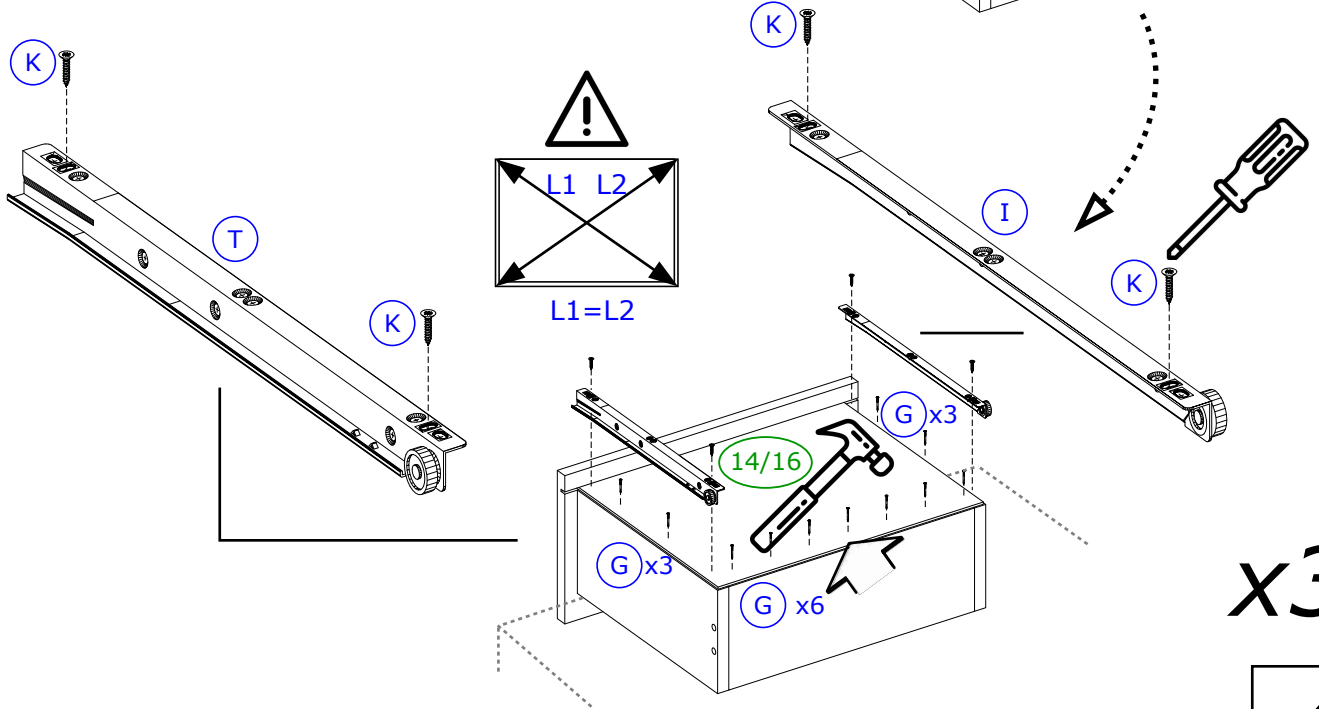
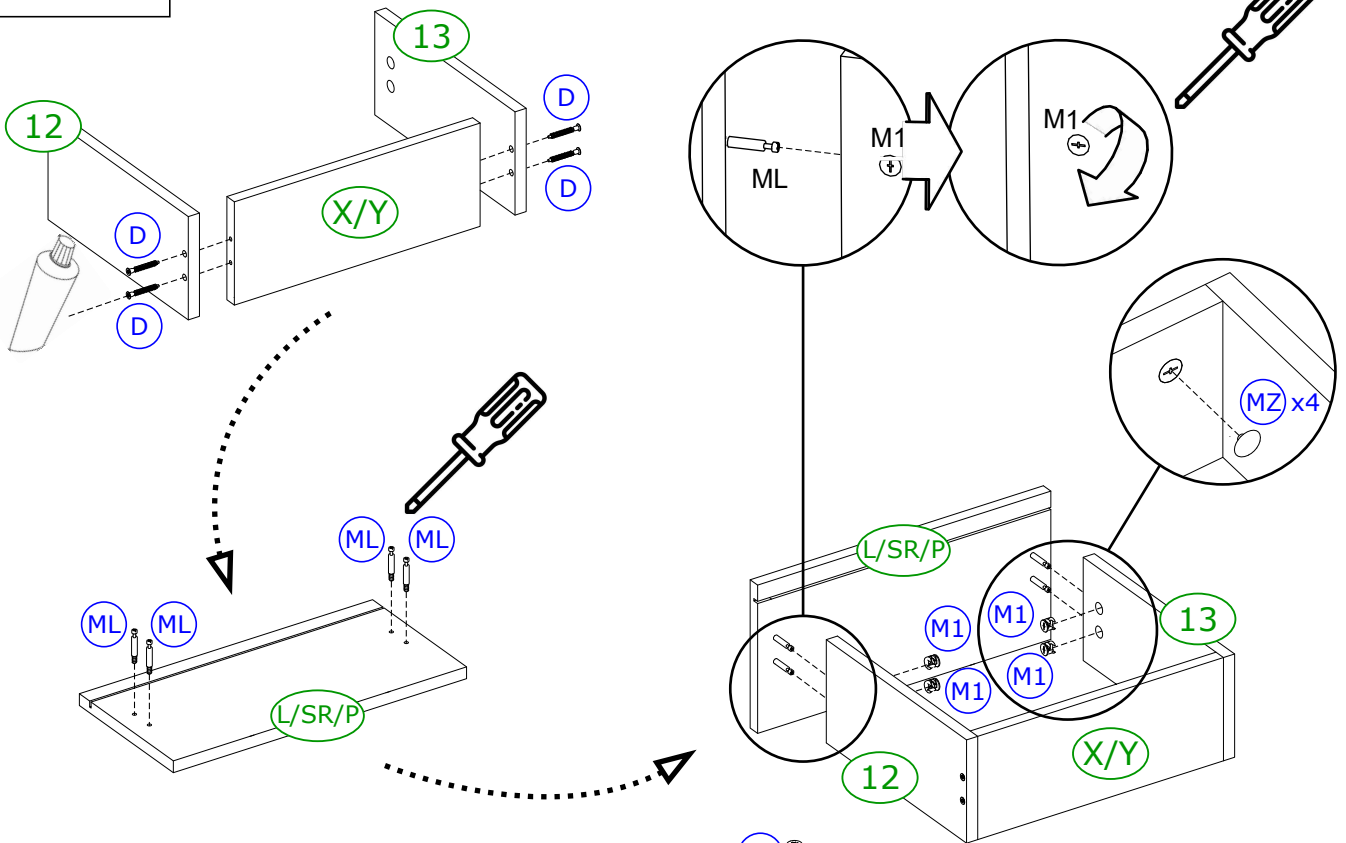

x3

4

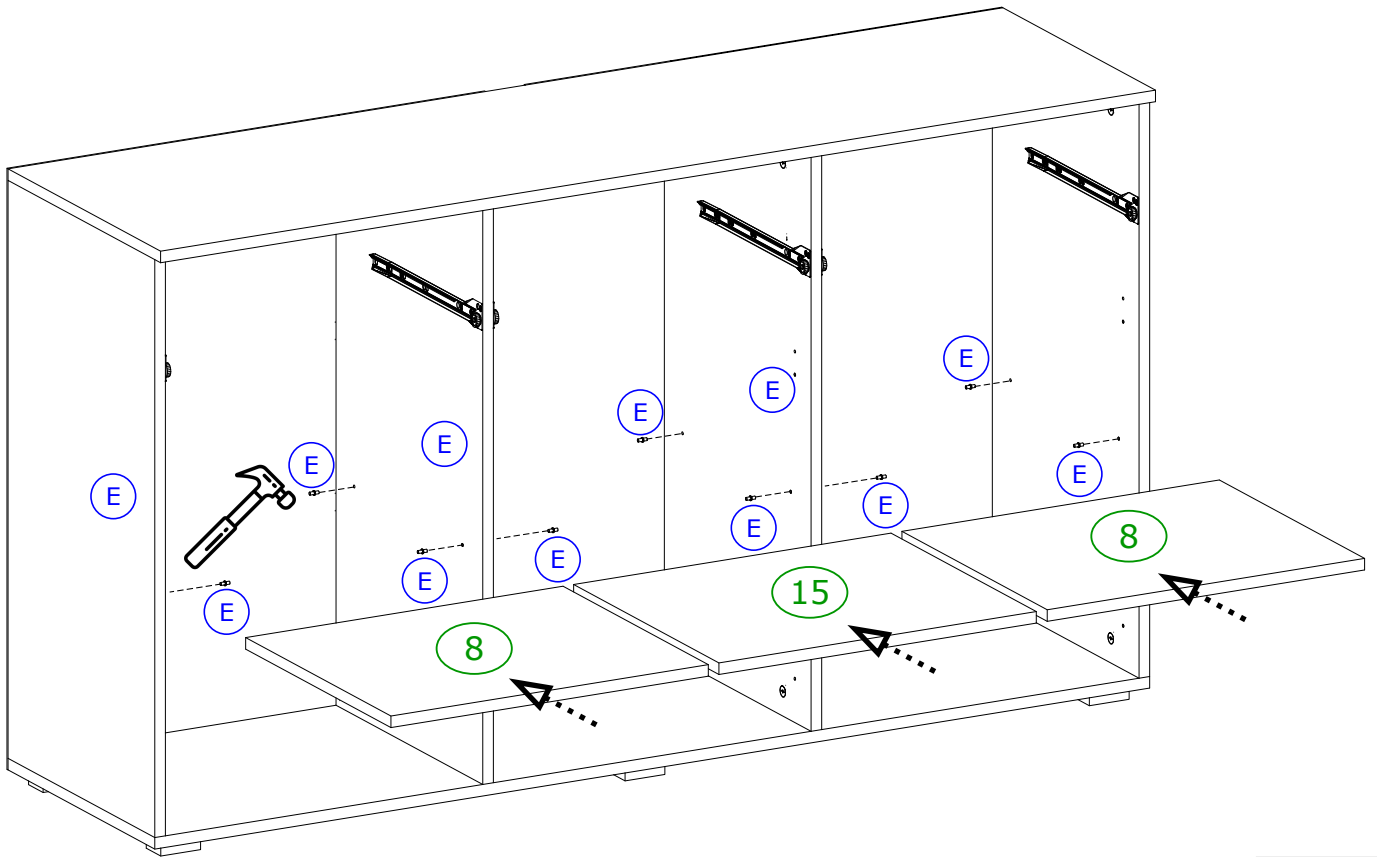
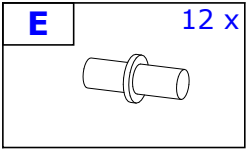

5

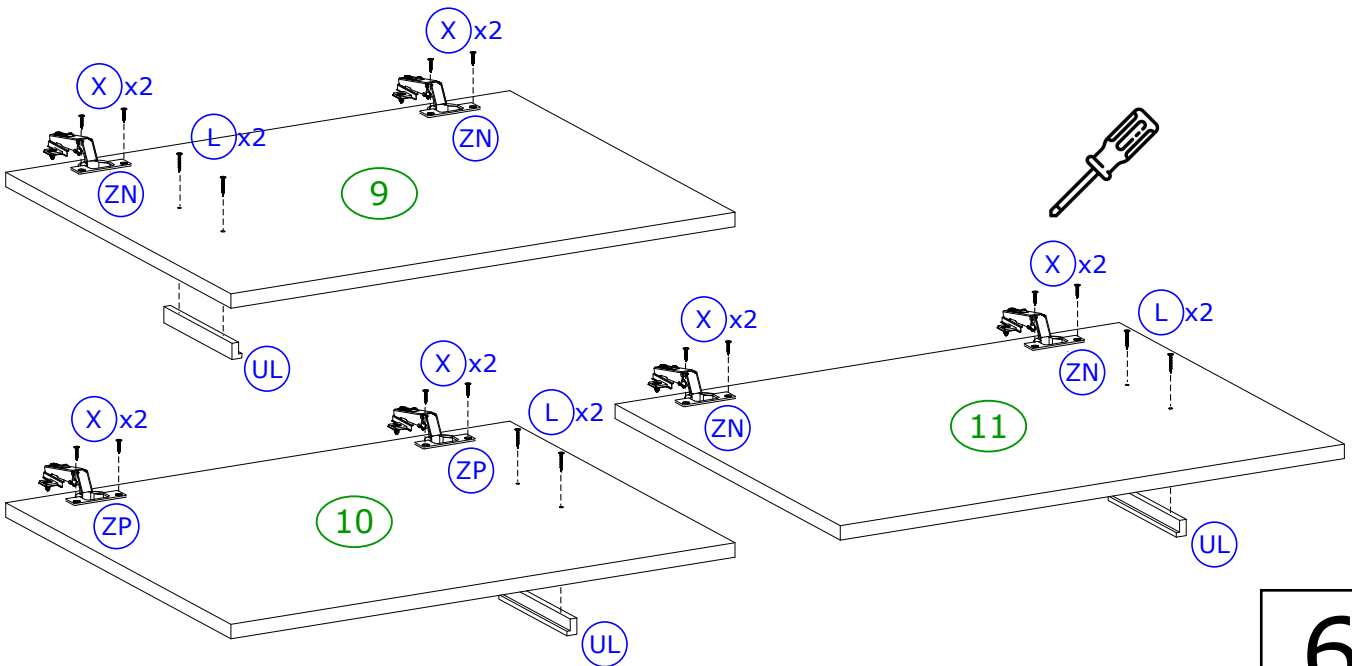
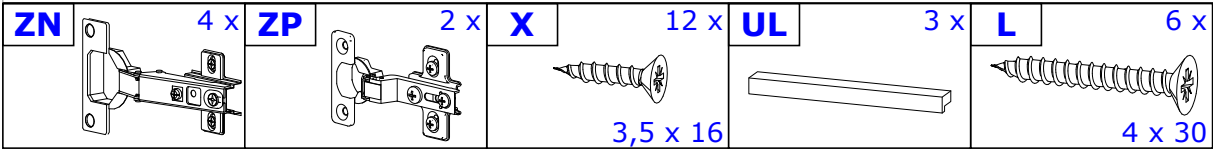

6

